



modello:
model:

CERCHIETTO

codice:
code:

6391

design:

UT Egoluce

anno - year:

2012

tipologia:

faretto da incasso

tipology:

recessed spotlight

materiali:

alluminio

materials:

aluminium

luce:

diretta/diffusa

light:

direct/diffuse

sorgente luminosa:

/XW LED max 2W 500mA 189lm 2700K

light source:

/WW LED max 2W 500mA 199lm 3000K

/W LED max 2W 500mA 209lm 4000K

/B LED max 2W 500mA LED BLU

grado IP - IP grade:

44

peso netto - net weight:

0,04 Kg

finitura:

.01 bianco

finishing:

.01 white

optional:

**0216 controcassa in materiale plastico
plastic box**

**0213 kit: box + plaster traforato
kit: box + perforated plaster**

marcatura:

CE

marking:

simboli costruttivi:
symbols:



Dimensioni - Dimensions

 3 cm

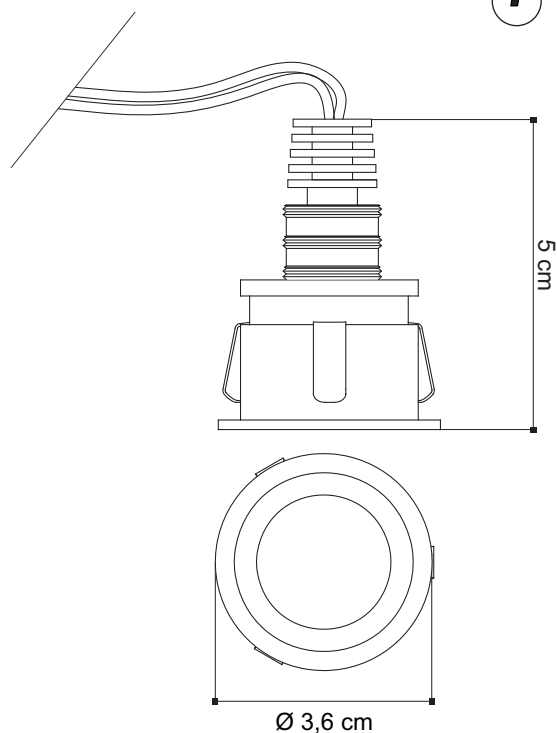

SOLO COLLEGAMENTO IN SERIE - ONLY SERIAL CONNECTION

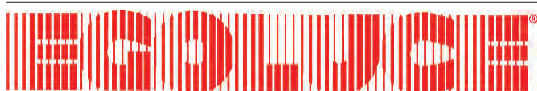
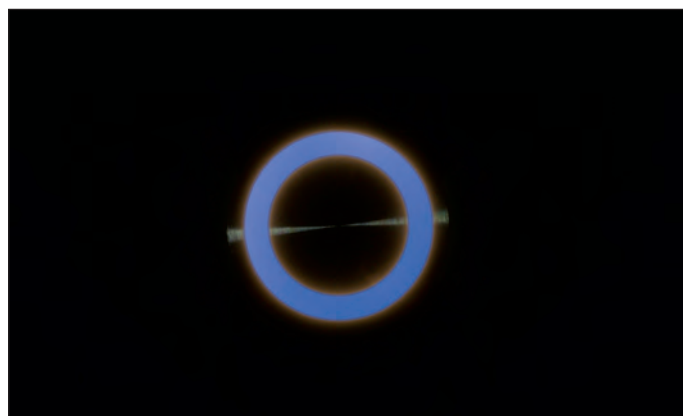
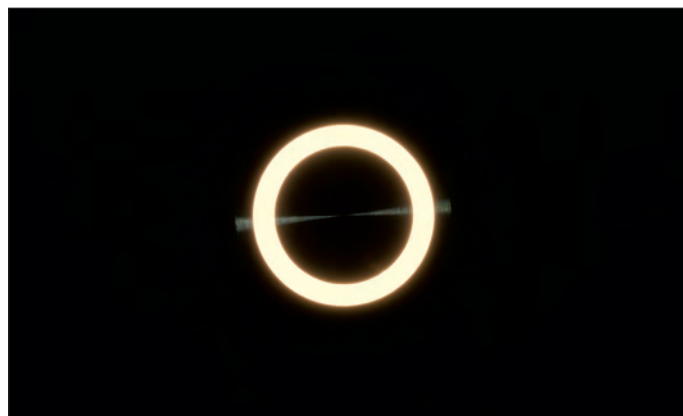

EGOLUCE s.r.l., via I. Newton 12 - 20016 Pero - Milano
telefono +39 02 339586.1 - fax. +39 02 3535112
e-mail: info@egoluce.com - <http://www.egoluce.com>

La presente scheda tecnica è di proprietà di EGOLUCE srl. Tutti i diritti sono riservati. Le fotografie, le descrizioni degli apparecchi, disegni quotati ed i valori fotometrici menzionati sono a titolo indicativo e non costituiscono alcun impegno per la nostra società che si riserva di apportare, in qualsiasi momento e senza preavviso, tutte le modifiche che riterrà opportune.

LED DRIVERS in corrente continua
LED DRIVERS constant current
0127

LED driver
 IN: 100 - 240V
 OUT: 500 mA
 1-6 Power LED 2W

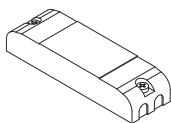

05
 C **RU** US
 SELV CLASS 2

11,6 x 3,4 x 2 cm  4 cm

0169/50**Multipower LED driver**

IN: 220 - 240V
 OUT: 500mA
 min.4-max15 Power LED 2W

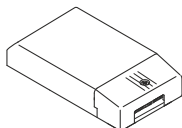

SELV 

13 x 7,5 x 3 cm  8,5 cm

DRIVERS DIMMERABILI in corrente continua
DIMMABLE LED DRIVERS constant current
0129 Dimmer Led**Multipower dimmable driver**

IN: 110 - 240V
 OUT: 500 mA, 1-14 Power LED

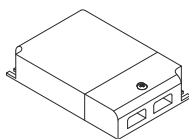



10,5 x 7 x 2,2 cm  7,2 cm SELV   C **RU** US 

0129/DALI Dimmer Led**Multipower dimmable driver**

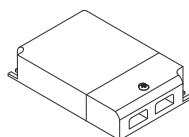
IN: 110 - 240V
 OUT: 500 mA, 2-12 Power LED



10,5 x 7 x 2,2 cm  7,2 cm SELV   C **RU** US

0141/DALI**LED driver**

IN: 110 - 240V
 OUT: 500 mA, 1-11 Power LED

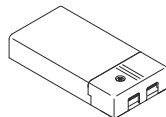

11,1 x 5,2 x 2,5 cm  5,5 cm

  C **RU** US

0141/DIM**LED driver**

IN: 110 - 240V
 OUT: 500 mA, 1-11 Power LED

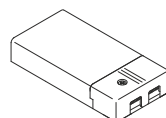

Versione **PUSH** non sincronizzabile - **PUSH** version not synchronizable

11,1 x 5,2 x 2,5 cm  5,5 cm    C **RU** US

0145 Dimmer Led Maxi**Multipower dimmable driver**

IN: 110 - OUT: 500 mA, 1-21 Power LED

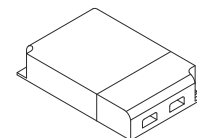

12,3 x 8 x 2,2 cm  8,4 cm SELV    C **RU** US

0145/DALI Dimmer Led Maxi**Multipower dimmable driver**

IN: 110 - 240V
 OUT: 500 mA, 1-21 Power LED

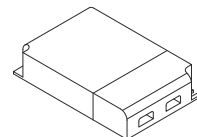

12,3 x 8 x 2,2 cm

 8,4 cm SELV     C **RU** US

0133

Cavo di sincronizzazione per dimmer Led Sincronization
 cable for dimmer Led
 (art. 0129 - art. 0129/DALI - art. 0145 - art. 0145/DALI)



L 150 cm

0726/DIM**LED dimmer**

TAGLIO DI FASE (IGBT-TRIAC, TRAILING EDGE-LEADING EDGE)
 PHASE CUT-OFF (IGBT-TRIAC, TRAILING EDGE-LEADING EDGE)
 IN: 220 - 240V
 OUT: 500 mA, 1-12 Power LED

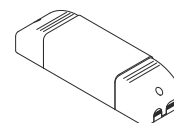

16,5 x 4,5 x 3,5 cm  5,6 cm  IGBT-TRIAC  SELV

IP LED DRIVERS in corrente continua
IP LED DRIVERS constant current
0143/IP**LED driver**

IN: 220 - 240V
 OUT: 500 mA
 1-8 Power LED 2W

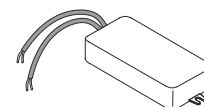

8,2 x 3,9 x 2 cm  4,5 cm

SELV IP67

ACCESSORI
ACCESSORIES

0216 Controcassa in materiale plastico
 Plastic Box



0213 Kit: box + plaster traforato
 Kit: box + perforated plaster

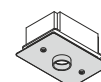

La presente scheda tecnica è di proprietà di EGOLUCE srl. Tutti i diritti sono riservati. Le fotografie, le descrizioni degli apparecchi, disegni quotati ed i valori fotometrici menzionati sono a titolo indicativo e non costituiscono alcun impegno per la nostra società che si riserva di apportare, in qualsiasi momento e senza preavviso, tutte le modifiche che riterrà opportune.

EGOLUCE s.r.l., via I.Newton 12 - 20016 Pero - Milano
 telefono +39 02 339586.1 - fax. +39 02 3535112
 e-mail: info@egoluce.com - http://www.egoluce.com